

Internal Gear Unit

for motor/pump function
Series QXEM

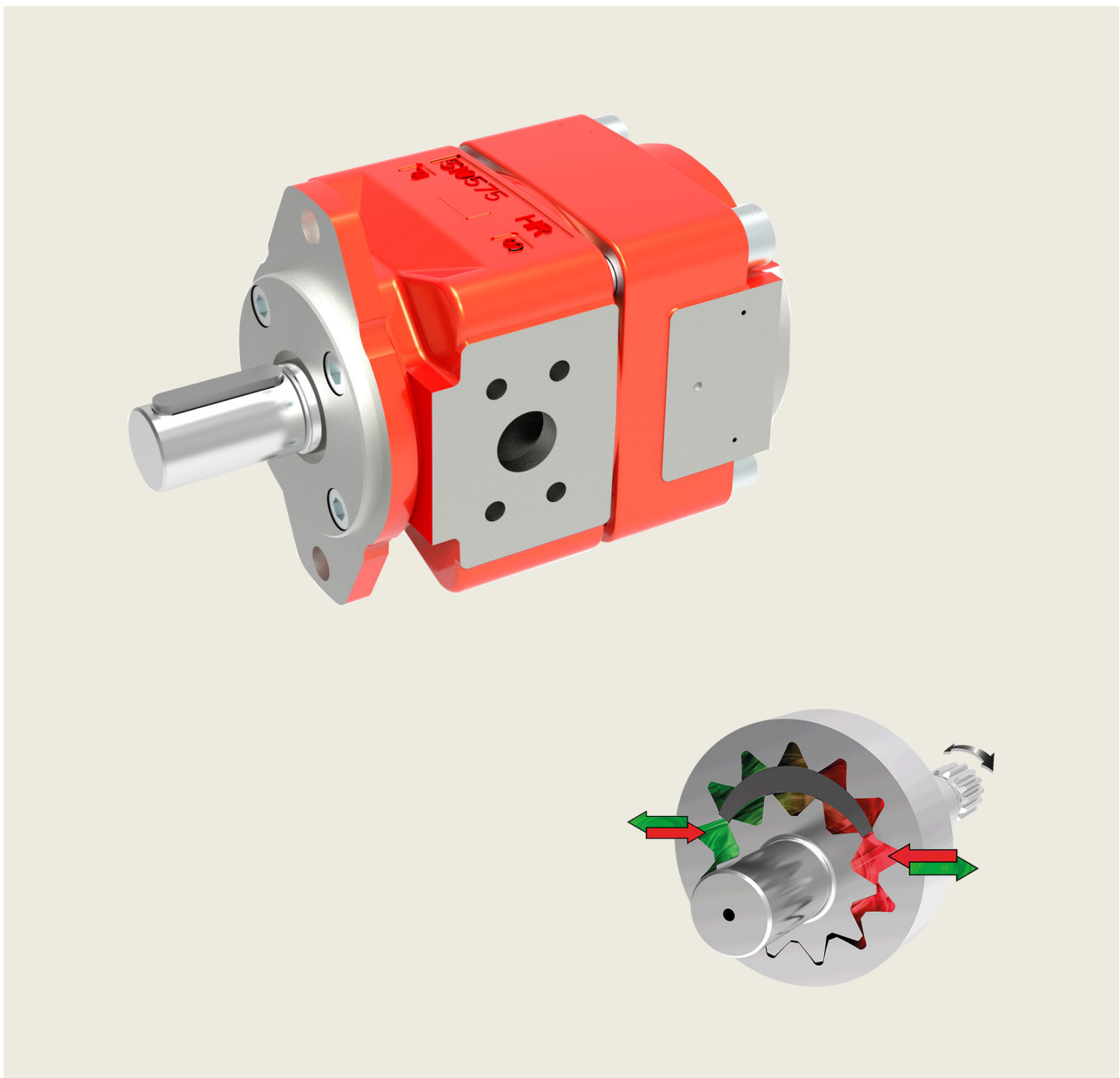

Contents		Page
1	General	5
	1.1 Product description	5
	1.2 Advantages	5
	1.3 Application	5
2	Technical data	5
	2.1 General	5
	2.2 Main characteristics	6
3	Performance graphs	7
	3.1 Minimum speed limit for pump and motor operation	7
	3.2 Noise level	7
	3.3 Efficiency (η)	9
	3.4 Starting torque	9
4	Dimensions	10
5	Ordering details	11
	5.1 Ordering example	11
	5.2 Standard configuration	11
	5.3 Options	11
	5.4 Direction of rotation	11
6	Fluid cleanliness	12
7	Note	12
8	Fluid cleanliness	12
9	Operational reliability	12
10	Accessories	13
	10.1 Bolt-on valves - SAE J518 code 61 / ISO 6162-1 pattern	13
	10.2 Pipe flanges - high pressure type	14
	10.3 Pipe flanges - high pressure type	15

1 General

1.1 Product description

For applications requiring variable-speed multi-quadrant operation, Bucher Hydraulics has developed a special version: The QXEM internal gear unit.

One of the central points in the QXEM series is its symmetric construction, with identical high and low pressure areas. With special metering grooves and lubrication systems as well as two same-size pressure-tight connections, the design is specially optimised for 2 and 4 quadrant modes and is thus ideally suited to both directions of rotation at high and low pressures.

Thanks to the use of high-precision gear parts with a pinion shaft (pinion and shaft as one component), extremely low pulsation levels are produced even at low speeds.

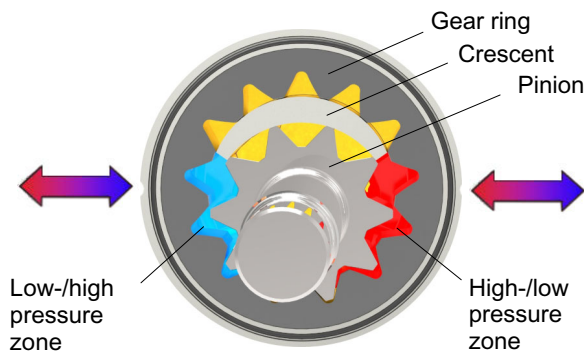

1.2 Advantages

- compact, non-compensated design
- pressure and flow pulsations are minimal, thanks to pinion-shaft technology
- first-rate reliability at both high and low speeds and in reverse mode
- field-proven in both fixed- and variable-speed drive
- long service life even under highly cyclical loading
- change of direction in the milliseconds range (pinion shaft)
- suitable for special fluids such as HFB, HFC, HFD and bio-degradables

1.3 Application

- Injection molding machines
- Hydraulic presses
- Waste compactors
- Die casting machines

2 Technical data

2.1 General

Characteristics	Unit	Description, value
Installation attitude		unrestricted
Mounting method (standard)		oval 2-hole flange to ISO 3019/1 (SAE): QXEM 3-6 oval 2-hole flange to ISO 3019/2 (metric) QXEM 2+8
Direction of rotation		unrestricted
Drive method		in-line, by a flexible coupling
Hydraulic fluid		HLP mineral oils to DIN 51524, Part 2 HFB, HFD and HFC fluids to VDMA 24317 (other on request)
Max. admissible level of contamination of the hydraulic fluid		ISO 4406 class 20/18/15
Operating viscosity Starting viscosity	mm ² /s	10 ... 100 10 ... 300 (higher values on request)

Characteristics	Unit	Description, value
Hydraulic fluid temperature range	°C	min -20 / max +80 (but comply with viscosity limits) ideal range: +30 ... +60 / option 09: -20°C ... +100°C
Max. pressure at drain port	bar	1.5 absolute (higher values on request)
Accumulated pressure restriction		port P ₁ + port P ₂ ≤ continuous pressure
Seal material		NBR = standard FPM (Viton) = option 09

2.2 Main characteristics

IMPORTANT: The main characteristics are valid for hydraulic oils DIN 51524 with a viscosity of 42mm²/s.

Type	Displacement [cm ³ /U]		maximum Speed [min ⁻¹]		Operating pressure [bar]		Torque ³⁾ [Nm]				
	nominal	effective ¹⁾	Pump operat. ⁴⁾	Motor operating	conti- nuous	intermit- tent ²⁾					
QXEM22-005 QXEM22-006 QXEM22-008	005 006 008	5,1 6,3 7,9	3250	6000	210	250	17 21 26,5				
QXEM32-010 QXEM32-012 QXEM32-016	010 012 016	10,0 12,6 15,6					3050	5500	210	250	33,5 42 52
QXEM42-020 QXEM42-025 QXEM42-032	020 025 032	20,3 25,1 32,3									2900
QXEM52-040 QXEM52-050 QXEM52-063	040 050 063	39,1 50,3 63,4	2500	4500	210	250					
QXEM62-080 QXEM62-100 QXEM62-125	080 100 125	79,8 100,5 124,2					2250 2050 1800	4000	210	250	
QXEM82-160 QXEM82-200 QXEM82-250	160 200 250	161,9 200,0 247,7									1600 1500 1350

1) Due to manufacturing tolerances, there may be slight variations in the displacement.

2) Intermittent pressure for max. 20 sec/min but not more than 10% of the duty cycle.

3) Theoretical value at the maximum permitted continuous pressure. For starting torques, see section 3.

4) Minimum inlet pressure 0,98 bar absolute.

3 Performance graphs

3.1 Minimum speed limit for pump and motor operation

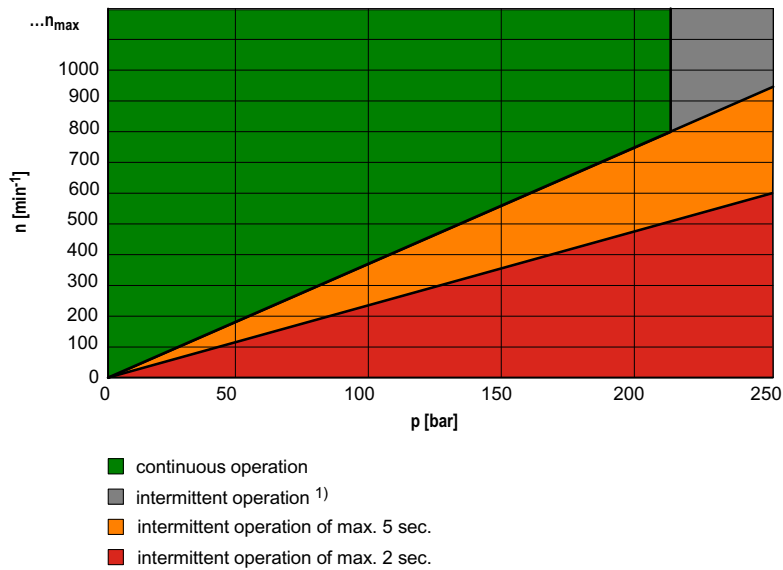

1) Intermittent pressure for max. 20 sec/min but not more than 10% of the duty cycle.

3.2 Noise level

Measured to DIN 45635 part 26 in low-echo noise measurement chamber, valid for single units with deviations of $\pm 1,5$ dB [A].

3.2.1 QXEM22

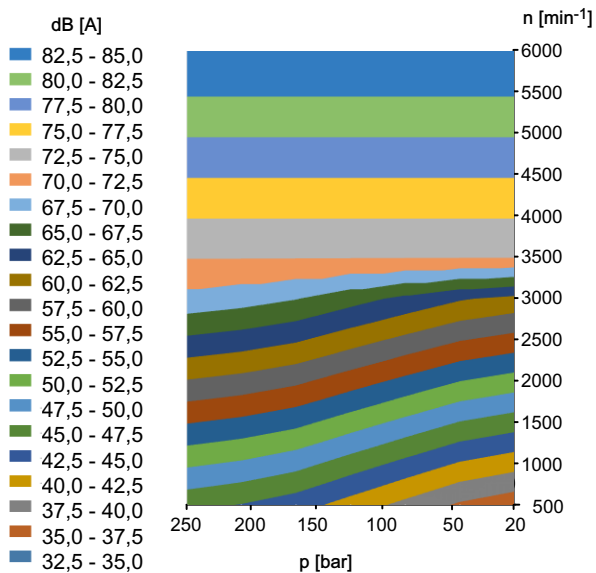

3.2.2 QXEM32

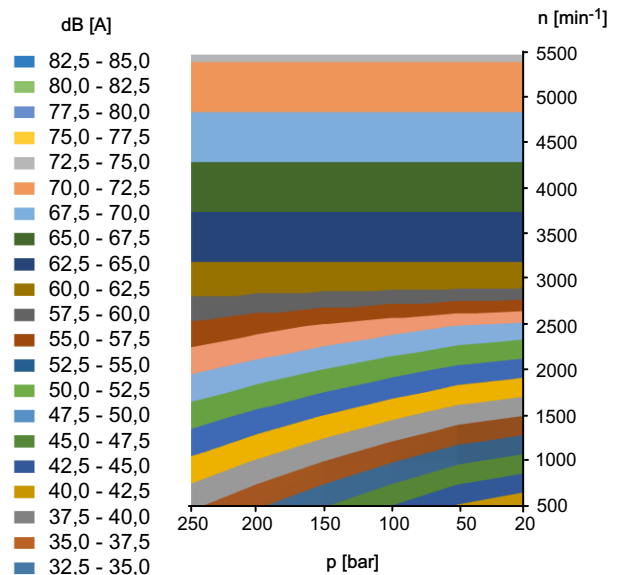

3.2.3 QXEM42

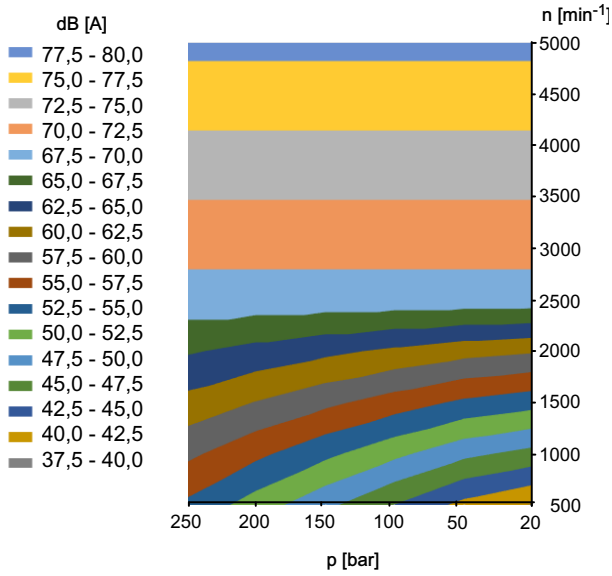

3.2.4 QXEM52

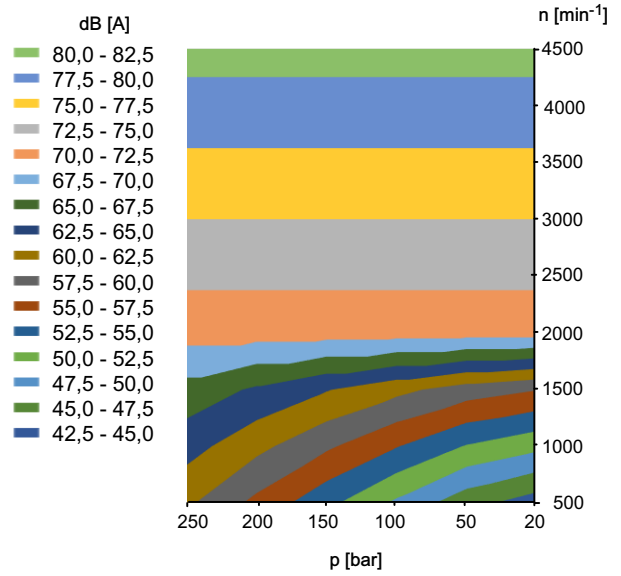

3.2.5 QXEM62

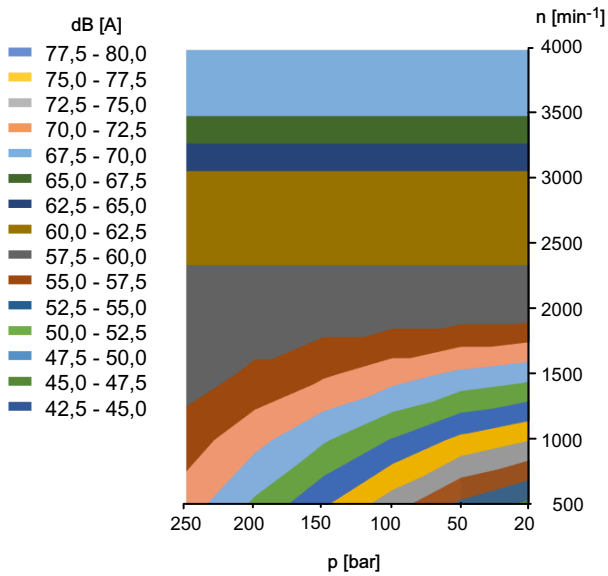

3.2.6 QXEM82

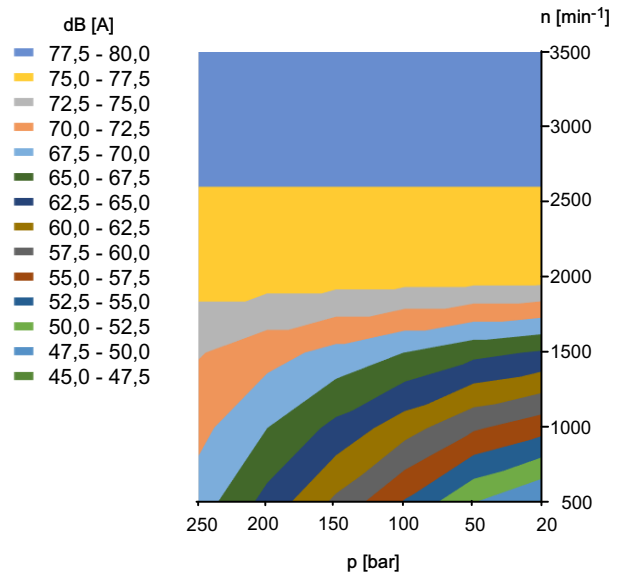

3.3 Efficiency (η)

Measured with viscosity 42 mm²/s, speed 1450 min⁻¹,

Solid line = continuous pressure / dashed line = max. intermittent pressure

3.3.1 Volumetric efficiency

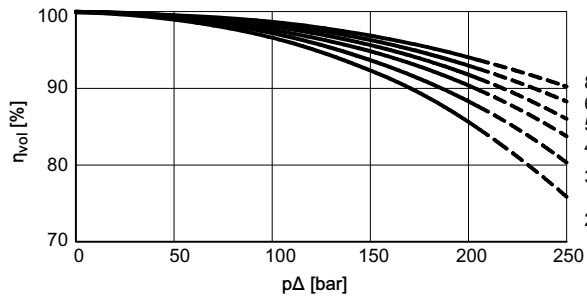

3.3.2 Hydro-mechanical efficiency

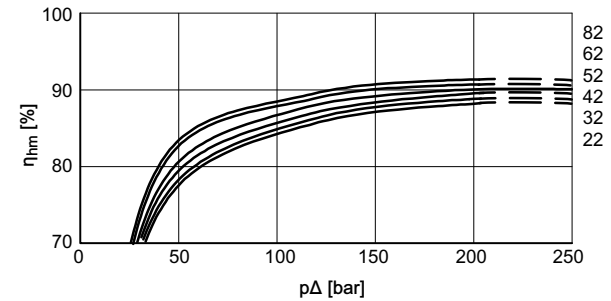

3.4 Starting torque

3.4.1 QXEM22

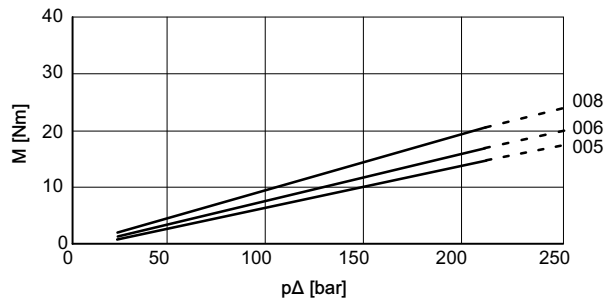

3.4.2 QXEM32

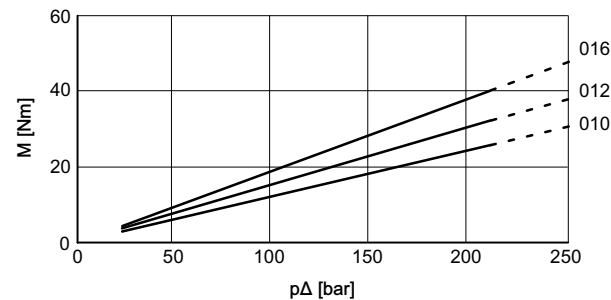

3.4.3 QXEM42

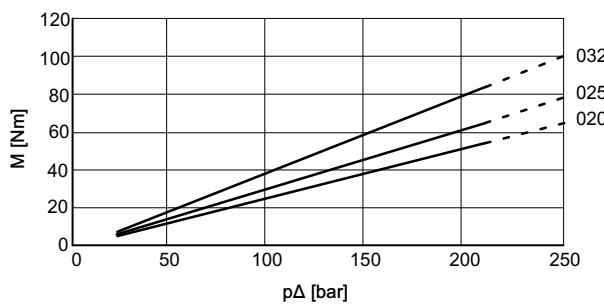

3.4.4 QXEM52

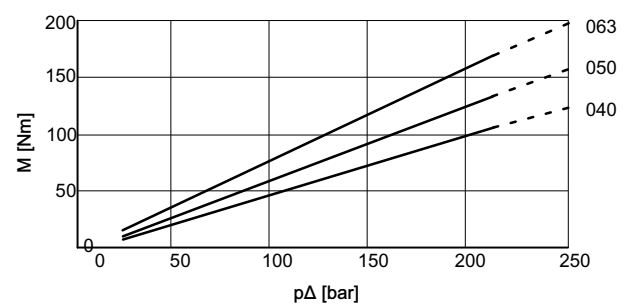

3.4.5 QXEM62

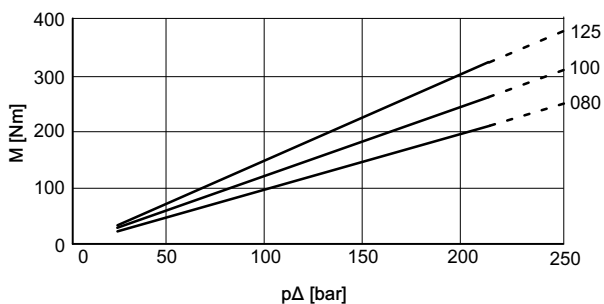

3.4.6 QXEM82

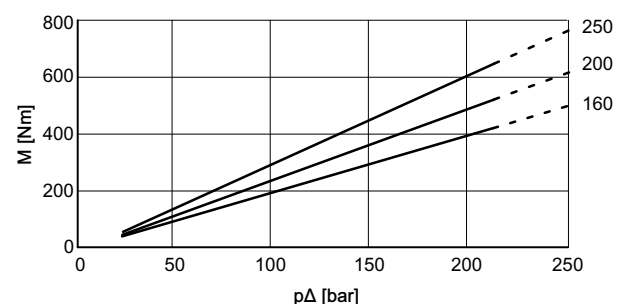

4 Dimensions

Frame size		2	3	4	5	6	8
Pressure range		2	2	2	2	2	2
Service ports to SAE J518 ¹⁾	P ₁ , P ₂	G1/2" ³⁾ thread	G 3/4" ³⁾ thread	1"	1 1/4"	1 1/2"	2"
Drain port to DIN 3852 Part 2	P _L	G 1/4"	G 1/4"	G 1/4"	G 1/4"	G 3/8"	G 1/2"
Mounting: oval 2-hole flange to ISO 3019/1 (SAE - size 3-6) ISO 3019/2 (Metr. - sizes 2+8)	A	118	132	170	212	267	330
	B(SAE)	-	106	146	181	229	-
	B(Metr.)	100	109	140	180	224	280
	C	9	11	14	18	22	26
	N(SAE)	-	82,55 -0,05	101,6 -0,05	127 -0,05	152,4 -0,05	-
	N(Metr.)	63 h8	80 h8	100 h8	125 h8	160 h8	200 h8
	O	8,5	8,5	10,5	12,5	16,5	20
V	6	6	7	7	7	9	
Mounting: oval 2-hole flange to ISO 3019/1 (SAE - size 3-6) ISO 3019/2 (Metr. - sizes 2+8)	X(Metr.)	9	9	12	14	18	22
	Y(Metr.)	85	103	125	160	200	250
Shaft end: cylindrical, to ISO/R775 ²⁾	D	16 j6	20 j6	25 j6	32 j6	40 j6	50 j6
	E	28	36	42	58	82	110
	F	5	6	8	10	12	14
	G	18	22,5	28	35	43	53,5
	I	37	44	51	68	92	122
Housing	K	37,5	44	52,5	60,5	74	90
	L	121,5	145,5	177,5	211,5	249	314
	T1	43	53,5	67	88,5	110	138
	T2	43	60	70	88,5	110	138
	Z	100	120	125	156	195	250
Weight	kg	5,2	9,6	17,3	30,2	56,5	111,3

1) For SAE J518 code 61 bzw. ISO6162-1 pipe flange dimensions see section 10.

2) For other shaft ends, contact Bucher Hydraulics.

3) Threaded ports to DIN 3852 Part 2.

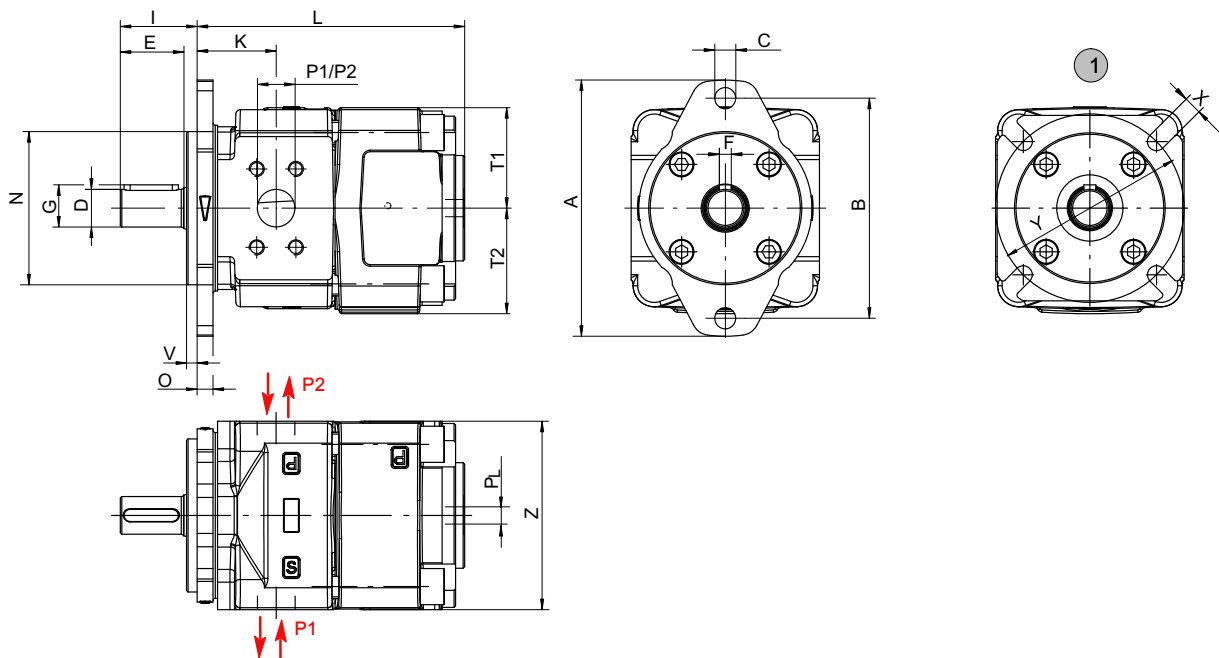

1 Option 66 = 4-hole mounting flange ISO 3019/2

5 Ordering details

		Q	X	E	M	5	2	-	0	4	0	N	*	*	*
Internal gear unit	QXEM														
Frame size	2 / 3 / 4 / 5 / 6 / 8														
Pressure range	2														
Geom. Displ./Consump. [cm ³ /rev]	5,1 - 247,7														
Direction of rotation, unrestricted	N (see section 5.4)														
Options	(to be inserted by the factory, see section 5.3 for a selection)														

5.1 Ordering example

Required:	Internal gear unit QXEM
Displ./Consump.:	40 cm ³ /rev
Continuous pressure:	210 bar
For use with mineral oil:	HLP
Ordering code:	QXEM 52-040 N

5.2 Standard configuration

- Direction of rotation - unrestricted
- 2-hole mounting flange to ISO 3019/1;
Frame size QXEM 3-6
- 2-hole mounting flange to ISO 3019/2;
Frame size QXEM 2+8
- Nitrile seals
- Cylindrical shaft end to ISO R775
- Separate drain port in rear cover of the drive unit
- Ports P1 + P2 both the same size
- High pressure shaft seal
- Black priming, flange without priming

5.3 Options

-O	=	without priming
09	=	FPM(Viton) seals, without priming
66	=	4-hole mounting flange to ISO 3019/2 (metric)
130	=	2-quadrant operation, service port dimensions as per QX pumps
		2-hole mounting flange to ISO 3019/2 (metric)

For other special features, contact Bucher Hydraulics.

5.4 Direction of rotation

Direction of rotation: right:
(clockwise, viewed from the shaft end) = oil flows from P₁ to P₂

Direction of rotation: left:
(counterclockwise, viewed from the shaft end) = oil flows from P₂ to P₁

6 Fluid cleanliness

QXEM internal gear units require a fluid with a minimum cleanliness level of ISO 4406 code 20/18/15.

We recommend the use of fluids that contain anti-wear additives for mixed-friction operating conditions. Fluids without appropriate additives can reduce the service life of pumps and motors. The user is responsible for maintaining, and regularly checking, the fluid quality. Bucher Hydraulics recommends a load capacity of $\geq 30 \text{ N/mm}^2$ to Bruggen DIN 51347-2.

7 Note

This catalogue is intended for users with specialist knowledge. The user must check the suitability of the equipment described herein in order to ensure that all of the conditions necessary for the safety and proper functioning of the system are fulfilled. If you have any doubts or questions concerning the use of these pumps, please consult Bucher Hydraulics.

8 Fluid cleanliness

Cleanliness class (RK) as per ISO 4406

Code ISO 4406	Dirt particle number / 100 ml		
	$\geq 4 \mu\text{m}$	$\geq 6 \mu\text{m}$	$\geq 14 \mu\text{m}$
23/21/18	8000000	2000000	250000
22/20/18	4000000	1000000	250000
22/20/17	4000000	1000000	130000
22/20/16	4000000	1000000	64000
21/19/16	2000000	500000	64000
20/18/15	1000000	250000	32000
19/17/14	500000	130000	16000
18/16/13	250000	64000	8000
17/15/12	130000	32000	4000
16/14/12	64000	16000	4000
16/14/11	64000	16000	2000
15/13/10	32000	8000	1000
14/12/9	16000	4000	500
13/11/8	8000	2000	250

9 Operational reliability

To ensure a reliable operation and a long service life of the QXEM internal gear units, a maintenance schedule must be prepared for the power unit, machine or system. The maintenance schedule must make sure that the provided or permissible operating conditions of the QXEM internal gear units are adhered to over the period of use.

In particular, compliance with the following operating parameters must be ensured:

- The required oil cleanliness
- The operating temperature range
- The fluid level

Moreover, the QXEM internal gear units and the system must be inspected at regular intervals for changes in the following parameters:

- Vibration
- Noise
- Differential temperature of internal gear unit – fluid in the tank
- Foaming in the tank
- Freedom from leakage



Changes in these parameters indicate wear of components (e.g. drive motor, coupling, internal gear unit, etc.). The cause must be immediately pinpointed and eliminated.

To provide high operational reliability of the QXEM internal gear unit in the machine or system, we recommend continuous, automatic checks of the above parameters and an automatic shutdown in the case of changes that exceed the usual fluctuations within the provided operating range.

Commissioning see operating instructions 100-B-000014

10 Accessories

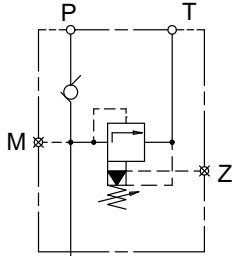
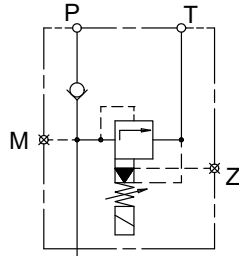
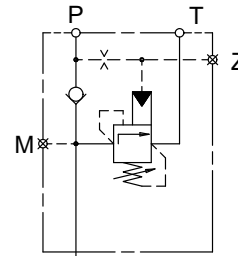
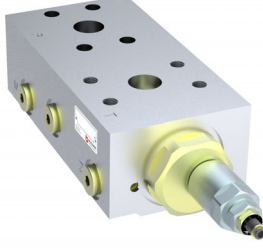
10.1 Bolt-on valves - SAE J518 code 61 / ISO 6162-1 pattern

Pressure relief valve A $\frac{S}{G}$ DF	Pressure relief valve solenoid control A $\frac{S}{G}$ DA	Accumulator charging valve AGSF
		
		
<p>Technical data sheet 100-P-000123</p>	<p>Technical data sheet 100-P-000119</p>	<p>Technical data sheet 100-P-0000124</p>

10.1.1 Examples for mounted bolt-on valves

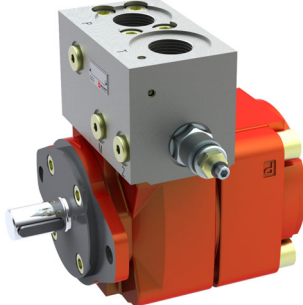
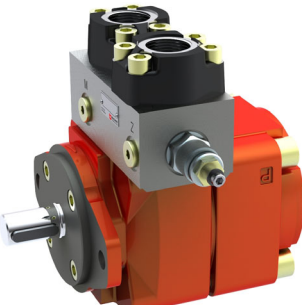
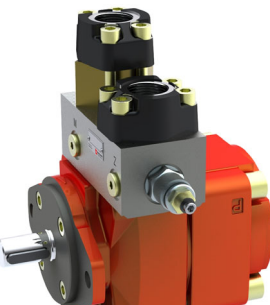
Bolt-on valve with threaded ports AGDF	Bolt-on valves with pipe flanges SAE ¹⁾ ASDF+RF	Bolt-on valve with pipe flanges SAE + RVSAE ²⁾ ASDF+RF+RVSAE+DPSAE+ZPSAE
		

1) Pipe flange see section 10.2 and 10.3.

2) Please ask Bucher Hydraulics GmbH for check valves.

IMPORTANT: Detailed information for bolt-on valves see www.bucherhydraulics.com

10.2 Pipe flanges - high pressure type

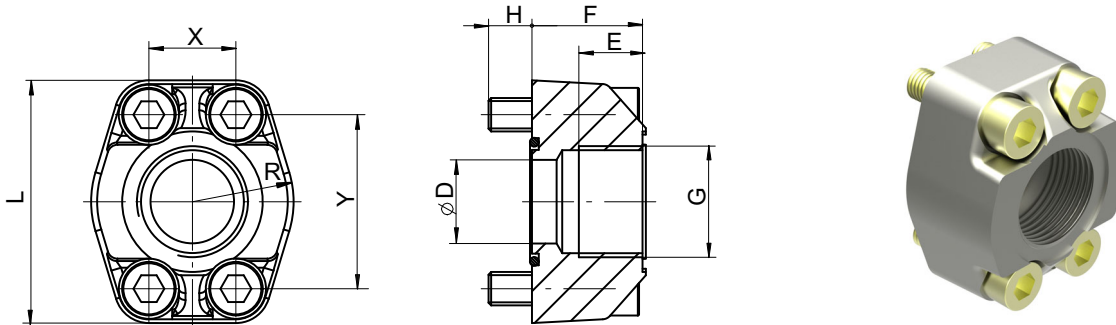

- Max. operating pressure 420 bar.
- Flange size SAE J518 code 61 / ISO 6162-1

Threaded pipe flanges are spot-faced for DIN 2353 pipe fittings.

Material: ST37 / for FPM (Viton) seals contact Bucher Hydraulics GmbH.

Ordering-number	Ordering code	Size	DØ	E	F	H	L	R	X	Y	Viton seal 90 Shore A	Retaining screws DIN912-12.9 / [Nm]	
100037000	RF 01-R08	G 1/2"	12,5	16	27	13	54	23	17,5	38	20,24x2,62	M8x30	30
100037010	RF 02-R10	G 3/4"	20	18	30	12	65	26	22,2	47,6	26,65x2,62	M10x30	60
100037020	RF 03-R11	G 1"	25	20	34	13	70	29	26,2	52,4	32,99x2,62	M10x35	60
100037030	RF 04-R12	G 1 1/4"	32	22	38	14	80	36	30,2	58,6	40,86x3,53	M10x40	60
100037040	RF 05-R13	G 1 1/2"	38	24	41	19	94	41	35,7	70	44,04x3,53	M12x45	120
100037050	RF 06-R14	G 2"	50	26	45	20	102	48	42,9	77,8	59,92x3,53	M12x50	120
100055470*	RF 07-R16	G 2 1/2" *	63	30	50	18	114	57	50,8	89	72,62x3,53	M12x45	120

* for RF07 only up to 210 bar be allowed.

10.3 Pipe flanges - high pressure type

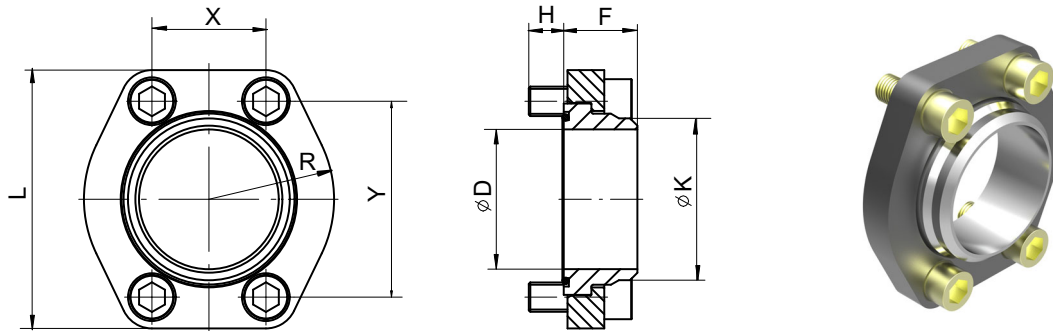

- Max. operating pressure 420 bar
- Flange size SAE J518 code 61 / ISO 6162-1

Material: HST37 / for FPM (Viton) seals contact Bucher Hydraulics.

Ordering number	Ordering code	SAE flange Size	D	K	F	H	L	R	X	Y	Viton seal 90 Shore 'A'	Retaining screws DIN 912-8.8 Torque [Nm]		pipe ¹⁾ O/dia. approx.
100062450	RN 07-S	2½"	63	75	35	14	120	57	51	89	69,44x3,53	M12 x 30	70	75
100063880	RN 08-S	3"	76	88			140,5	68	62	106,5	85,32x3,53	M16 x 40	180	88
100063890	RN 09-S	3½"	89	100	40	19	158,5	73	70	120,3	98,02x3,53	M16 x 40	180	100
100063900	RN 10-S	4"	103	115			168	79	78	130	110,72x3,53	M16 x 40	180	115

1) We recommend the use of seamless precision steel tube to DIN 2391 with wallthick max 6 mm.

info.kl@bucherhydraulics.com

www.bucherhydraulics.com

© 2019 by Bucher Hydraulics GmbH, D-79771 Klettgau

All rights reserved.

Data is provided for the purpose of product description only, and must not be construed as warranted characteristics in the legal sense. The information does not relieve users from the duty of conducting their own evaluations and tests. Because the products are subject to continual improvement, we reserve the right to amend the product specifications contained in this catalogue.

Classification: 420.245. 200